

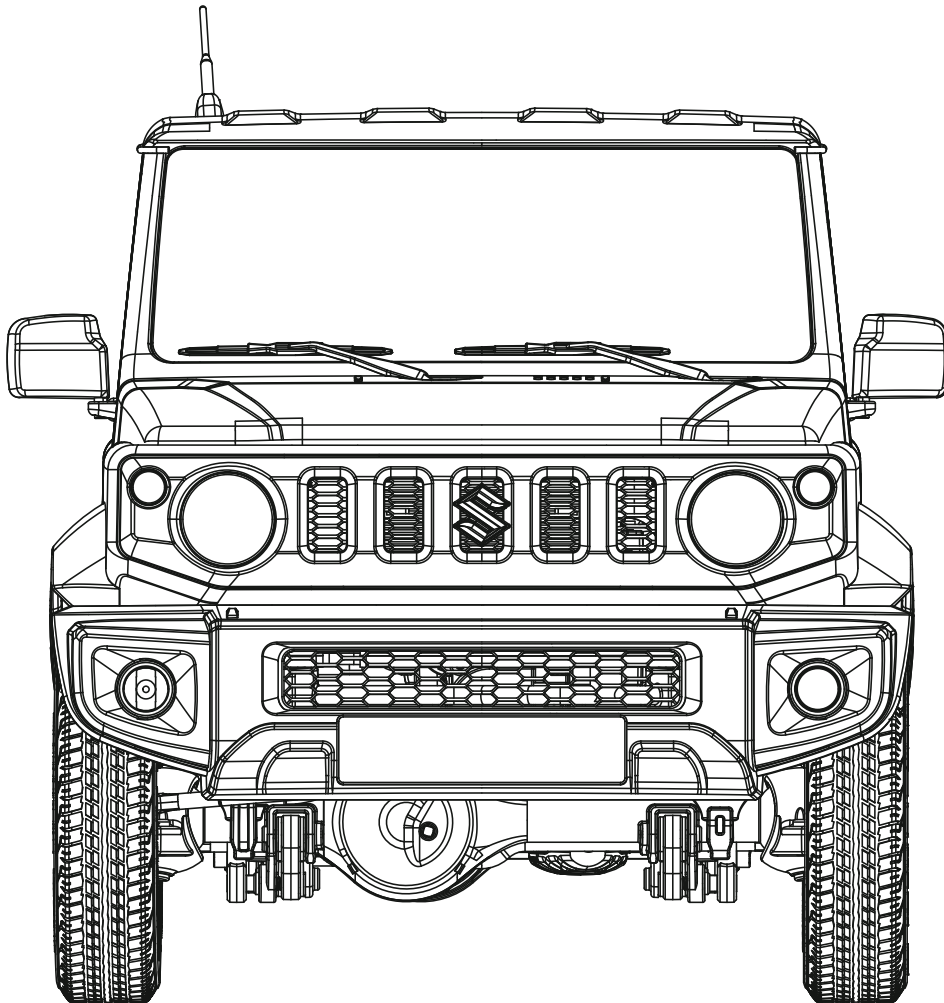

1:12 JIMNY



Instruction Manual
Bedienungsanleitung
Manuel d'utilisation
操作手册

SPECIFICATION

Length: 291mm
Width: 135mm

Height: 158mm
Wheel base: 187mm

Ground clearance: 16mm
Approach angle: 61°

Departure angle: 60°

TABLE OF CONTENTS

SAFETY PRECAUTIONS	03
RADIO SYSTEM	05
THROTTLE STICK POSITION	15
VEHICLE SETUP	15
OPERATING THE VEHICLE	16
CAR BODY ASSEMBLY	60
CHASSIS ASSEMBLY	61
COCKPIT ASSEMBLY	62
FRONT AXLE ASSEMBLY	63
MAIN GEAR BOX ASSEMBLY	64
REAR AXLE ASSEMBLY	65
SPRING SHOCK ASSEMBLY	66
TRANSMISSION GEAR BOX ASSEMBLY	66
STEERING GEAR	67
General list of accessories (I)	68
General list of accessories (II)	69

SAFETY PRECAUTIONS

Introduction

This manual is written to assist you in properly operating, maintaining and repairing the vehicle. As many of the components used are unique to this truck, please retain this manual as a future reference.

Composed of precision-made components, the FMS 1:12 Suzuki Jimny is not a toy, thus it is not suited for children under 14 years of age. Minors should be accompanied by an adult when operating. Failure to operate or maintain this vehicle in a safe manner can result in bodily harm.

It is the owner responsibility to operate this product in a safe manner. FMS and its distributors are not responsible in any way for any and all bodily harm and/ or property damage that may result from the use of this product.

Replace damaged components with original factory-parts. Pay special attention to the polarity of all vehicle wiring.

Safety, precautions and warnings

- Replace damaged components with original factory-parts. Pay special attention to the polarity of all vehicle wiring.
- Use common sense when selecting the environment to operate your vehicle. Do not operate near power cables, cellular/radio towers, deep water or unstable terrain. The operator is solely responsible for their actions.
- The product is composed of precision electrical components. It is critical to keep the product away from moisture and other contaminants.
- Always check the radio range of the vehicle prior to operation in order to prevent radio loss or interference.
- Operate this product within your ability. If the vehicle is dangerous to retrieve, it never worth the risk.
- Always turn on the transmitter before connecting the battery on the model. When turning off the model, always disconnect the battery first, and then turn off the model, always disconnect the battery first, and then turn off the transmitter. If this order is reversed, the model may become uncontrollable and cause serious damage.
- Never allow transmitter batteries to run low as it may cause loss of vehicle control.
- Plastics on the vehicle are susceptible to damage or deformation due to extreme heat and cold climate. Do not store the model near any source of heat such as oven or heater. Store the model indoors, in a climate-controlled, room temperature environment.

CE compliance information for the european union

The associated regulatory agencies of the following countries recognize the noted certifications for this product as authorized for sale and use.

UK	DE	DK	BG	SE	GZ	ES	NL	SK	HU	RO	FR	PT
FI	EE	LV	LT	PL	AT	CY	SI	GR	MT	IT	IE	LU

Declaration of Conformity

Products: 2.4GHz Controller

Equipment Class: 2

The objects of declaration described above are in conformity with the requirements of the specifications listed below.

Item Name : 2.4GHz Controller

The RED Directive 2014/53/EU

EN 60950-1:2006 + A11:2009 + A1:2010 + A12:2011 + A2:2013

EN 300 328 V2.1.1:2016

EN 301 489-1 V2.1.1:2017

EN 301 489-17 V3.1.1:2017

Please read this manual carefully prior to using. We are not responsible for any intentional damage or improper use. If you require any additional information or have any questions about the product or its use, please contact us via (www.fmsmodel.com).

This product is not a toy! (14+) Recommended for ages 14 and up. Adult supervision required for ages under 14 years old. Contains small parts, keep out of reach of children 3 years of age and younger.



Certification

FCC Compliance Statement

This device complies with Part 15 of the FCC Rules. Operation is subject to the following two conditions: (1) this device may not cause harmful interference, and (2) this device must accept any interference received, including interference that may cause undesired operation.

Warning: changes or modifications not expressly approved by the party responsible for compliance could void the user's authority to operate the equipment.

This equipment has been tested and found to comply with the limits for a Class B digital device, pursuant to Part 15 of the FCC Rules. These limits are designed to provide reasonable protection against harmful interference in a residential installation. This equipment generates, uses and can radiate radio frequency energy and, if not installed and used in accordance with the instructions, may cause harmful interference to radio communications. However, there is no guarantee that interference will not occur in a particular installation.

If this equipment does cause harmful interference to radio or television reception, which can be determined by turning the equipment off and on, the user is encouraged to try to correct the interference by one or more of the following measures:

1. Reorient or relocate the receiving antenna.
2. Increase the separation between the equipment and receiver.
3. Connect the equipment into an outlet on a circuit different from that to which the receiver is connected.
4. Consult the dealer or an experienced radio/TV technician for help.

RF Exposure Compliance

This equipment complies with FCC radiation exposure limits set forth for an uncontrolled environment. This equipment should be installed and operated with minimum distance 20cm between the radiator and your body. This transmitter must not be co-located or operating in conjunction with any other antenna or transmitter.

Environmentally friendly disposal

Old electrical appliances must not be disposed of together with the residual waste, but have to be disposed of separately. The disposal at the communal collecting point via private persons is for free. The owner of old appliances is responsible to bring the appliances to these collecting points or to similar collection points. With this little personal effort, you contribute to recycle valuable raw materials and the treatment of toxic substances.





FCC ID: N4ZR4A10

RADIO SYSTEM

Safety symbols

Pay close attention to the following symbols and their meanings. Failure to follow these warnings could cause damage, injury or death.

 Attention	Not following these instructions may lead to minor injuries.
 Warning	Not following these instructions may lead to major injuries.
 Danger	Not following these instructions may lead to serious injuries or death.

Safety guide



Prohibited



Mandatory



- Do not use the product at night or in bad weather like rain or thunderstorm. It can cause erratic operation or loss of control.
- Do not use the product when visibility is limited.
- Do not use the product on rain or snow days. Any exposure to moisture (water or snow) may cause erratic operation or loss of control.
- Interference may cause loss of control. To ensure the safety of you and others, do not operate in the following places:
 - 1、 Near any site where other radio control activity may occur
 - 2、 Near power lines or communication broadcasting antennas
 - 3、 Near people or roads
 - 4、 On any body of water when passenger boats are present
- Do not use this product when you are tired, uncomfortable, or under the influence of alcohol or drugs. Doing so may cause serious injury to yourself or others.
- The 2.4GHz radio band is limited to line of sight. Always keep your model in sight as a large object can block the RF signal and lead to loss of control.
- Do not touch any part of the model that may generate heat during operation, or immediately after use. The engine, motor or speed control, may be very hot and can cause serious burns.



- Misuse of this product may lead to serious injury or death. To ensure the safety of you and your equipment, read this manual and follow the instructions.
- Make sure the product is properly installed in your model. Failure to do so may result in serious injury.
- Make sure to disconnect the receiver battery before turning off the transmitter. Failure to do so may lead to unintended operation and cause an accident.
- Ensure that all motors operate in the correct direction. If not, adjust the direction first.
- Make sure the model stays within the systems maximum range to prevent loss of control.

Introduction

From the amazingly detailed interior, outer body, chassis and suspension, this is an RC model that replicates its full-size counterpart in virtually every area. The 1:12 Suzuki Jimny is ready to conquer the wilderness.

Realistic Body Details

- Officially licensed product of the Suzuki Motor Corporation.
- Ready-to-Run 4WD.
- Painted body in the original coating, with stainless marks using the photo-etching technique.
- Electroplating Suzuki logo and light cups.
- Photo-etching honeycomb grille and authentic movable rear-view mirror.
- Fine wheel artwork mounted with natural rubber tires.
- Bumpers, wheel fenders and roof can be disassembled for personal modification.
- Outstanding car light system with up to 15 LEDs.

Headlights: Full Beam / Dipped

Turn signals: Activated when turning / Dual flash switch

Fog lights: Front & rear fog lights can be activated remotely

Brake lights: Activated when parking

Reverse lights: Activated when reversing

Chic Interior

- Lift the hood for a featured lifelike scale engine with delicate detailing.
- Side doors open similar to the real Jimny.
- The steering wheel is driven by an independent servo and linked to the front wheel steering.
- Adjustable front seats, a perfect match for 1:12 figures.
- Open the backdoor, flatten the rear seats and enjoy some spacious storage!
- The trunk features a hidden storage area.
- Super detailed interior and dashboard.

Robust Chassis

- Solid frame-full chassis structure.
- Metal frame rails.
- Front & rear 3-link rigid axle suspension with coil spring.
- The scale engine houses a 180 motor with a two-speed transmission.
- Metal gears. Metal gears.
- 25 stainless steel ball bearings.
- Super detailed interior and dashboard.
- Battery, servo, receiver, ESC, light control — all under the hood.

Transmitter instruction

Introduction

FS-R4A1 based on ANT protocol is a three-in-one receiver with ESC and LED light group control board. It has an external single antenna, can output PWM signal and light control signal, can implement two-way transmission, adopts automatic binding, and has a compact design, which can be adapted to various model cars.

Transmitter Overview

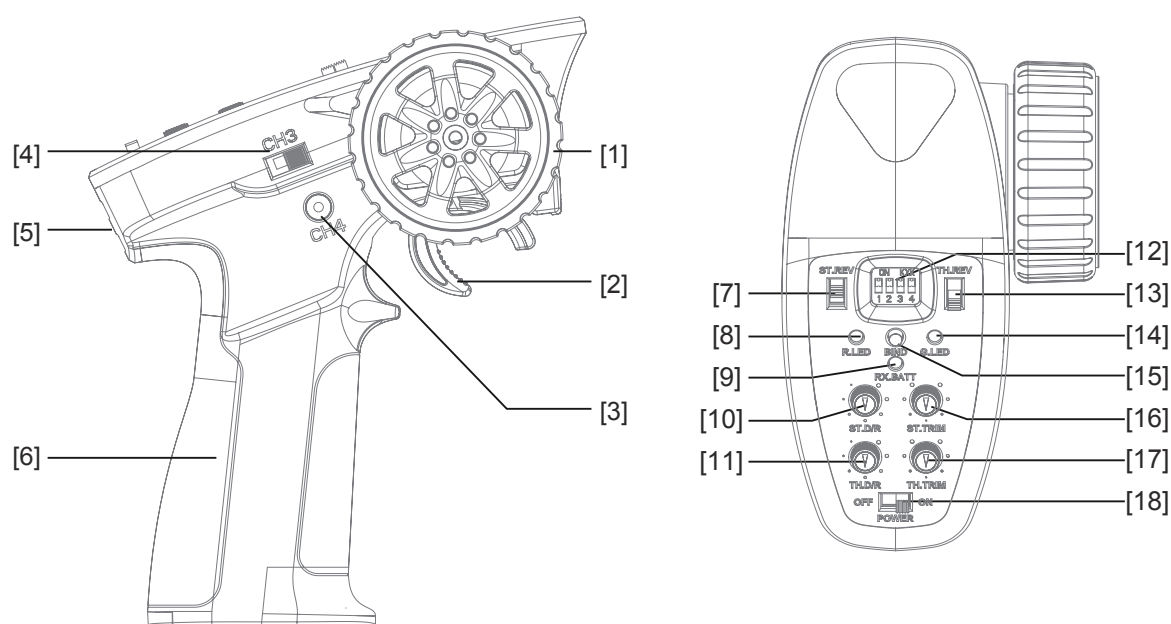

[1]	Traversing handwheel, 35 degrees on each side (CH1)	[10]	ST.D/R
[2]	Throttle button, 25 degrees in front and 12.5 degrees at rear (CH2)	[11]	TH.D/R
[3]	Push button switch (CH4) [Push button function is flip type]	[12]	Switch to the electric adjustment mode
[4]	Three-position toggle switch (CH3)	[13]	TH.REV
[5]	Lanyard hole	[14]	G.LED
[6]	Handle, 4*AAA battery compartment	[15]	BIND
[7]	ST.REV	[16]	ST.TRIM
[8]	R.LED	[17]	TH.TRIM
[9]	RX.BATT	[18]	Power Switch

Overview

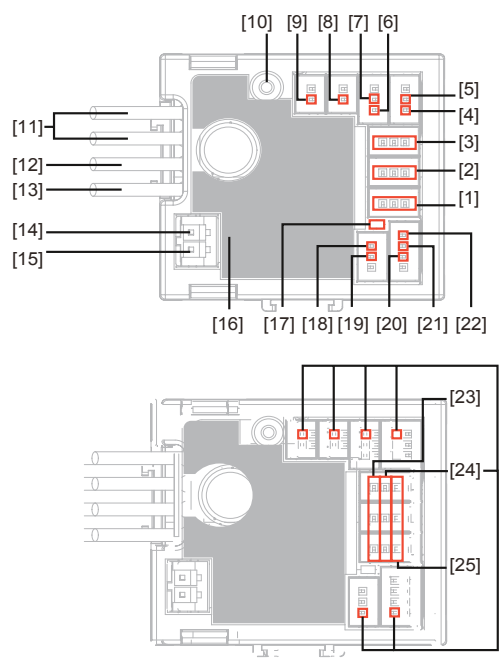

- [1] CH1
- [2] CH3
- [3] CH4
- [4] Left-turn light port
- [5] Head light port
- [6] Right-turn light port
- [7] Head light port
- [8] Fog light port
- [9] Fog light port
- [10] Antenna
- [11] Power switch
- [12] Battery line "+"
- [13] Battery line "-"
- [14] Motor port "+"
- [15] Motor port "-"
- [16] Stickers
- [17] LED
- [18] Left-turn light port
- [19] Right-turn light port
- [20] Reversing light port
- [21] Brake light port
- [22] Taillight port
- [23] Signal pin
- [24] Power "+"
- [25] Power "-"

Specifications

- Product Name: FS-R4A1
- Adaptive transmitter: FS-MG41
- Model Type: Car
- Channels: 4
- Numbers of Light Interfaces: 7
- RF: 2.4GHz ISM
- 2.4G Protocol: ANT
- Antenna: Single antenna
- Input Power: Lipo (2S)/NiMH (5~7Cell)
- BEC Output: 6V/1A
- Continuous/Peak Current: 10A/50A
- Data Output: PWM
- Temperature Range: -10°C—+60°C
- Humidity Limit: 20%~95%
- WaterProof: PPX4
- Online Update: No
- Dimensions: 33mm*30mm*12mm
- Weight: About 11g
- Certification: CE, FCC ID: N4ZR4A10

Binding

The receiver automatically enters the binding state once it is powered on.
 Press the **BIND** Key to turn on the transmitter and allow it to enter its binding state. Here, **G.LED** flashes quickly, and operator releases the **BIND** Key.

1. When the receiver is powered on and waits for 1 second, it will automatically enter the binding state if it is not connected;
2. After the binding is successful, the LED indicator of the receiver is always on.

Notes: (1) Set the transmitter to its binding state first, and then set the receiver to its binding state. If the binding is not completed within 10s, the indicator light of the receiver will enter its slow flashing state.
 (2) If re-binding is successful, all the settings of the car lights will be restored to their default values.

ESC protection

This receiver has multiple prompt functions such as power-on self-check display, overheating alarm prompt, and low/high voltage alarm prompt.

- Self-check display: all car lights will be on for 1S when the receiver is powered on;
- Overheating alarm: When the internal temperature of the ESC is detected to exceed 110°C, motor has no output, all car lights flash promptly, and the normal output will be restored when the temperature is lower than 70°C;
- Low/high voltage alarm: When the receiver enters the low voltage protection, motor has no output, and all the lights flash slowly; when the receiver enters the high voltage protection, all channels have no output. All car lights flash promptly.

Headlight control

The lights control works mainly through the setting of transmitter to achieve the conversion between lighting state and lighting mode.

This receiver presets five light control modes and each mode shares the same light state of reversing lights, that is, when the model car is reversed, the reversing lights stay on with high brightness, and vice versa off. While its turn signals, headlights, brake lights, taillights and fog lights vary from one another as described below:

- **Default mode:** Default mode: In this mode, whether the model car turns or not, the turn signal stays off; when the brake is applied, the brake light is on with high brightness and vice versa off; all the headlights, taillights and fog light stay off.
- **Mode A:** In this mode, when the model car turns, turn signals shows slow flashing and when brake is applied, the brake light is on with high brightness, vice versa low light; The headlights are in a low light state; the taillights and fog lights are always off.
- **Mode B:** In this mode, when the model car turns, turn signals shows slow flashing; when brake is applied, the brake light is on with high brightness, vice versa low light; the headlights are on with high brightness; the taillights and fog light are always off.
- **Mode C:** In this mode, whether the model car turns or not, the turn signal keeps slow flashing; when brake is applied, the brake light is on with high brightness, vice versa low light; the headlights are on with high brightness, the taillights and fog light are on.
- **Mode D:** In this mode, when the model car turns, the turn signal shows slow flashing; when brake is applied, the brake light is on with high brightness, vice versa off; the headlights are in constant off state; the tail lights and fog light are in constant on state.

Note: (1) Press button CH4 on the remote control to switch the working mode in turn, from default mode, mode A, mode B, mode C to mode D. Each press comes with a switch in mode.

(2) Default mode is on every time when you turn on the system.

(3) Mode C represents the emergency light working state, with both the left and right turn signal lights working together as emergency lights by synchronously slow flash.

ESC function instructions

1. Connect related equipment:

Make sure the ESC is off before connection. Connect the motor with M+ and M- of ESC. Connect the steering servo to the 3Pin interface marked with "ST" of ESC (- + S connected correspondingly). Connect the battery with the positive and negative poles of ESC correspondingly.

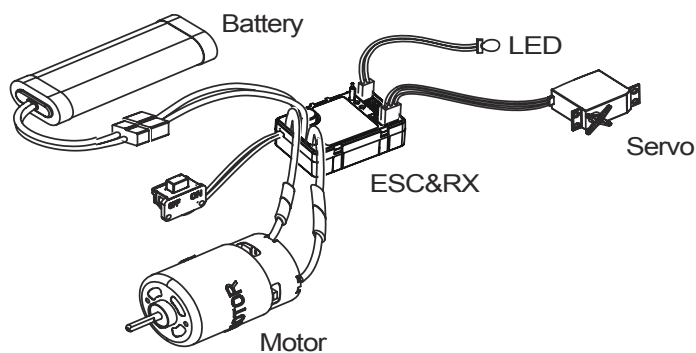

2. Normal boot, identification throttle midpoint:

After connecting related equipment as step 1, turn on the radio first, move the throttle trigger to the neutral position. Turn on the switch of ESC at last. The receiver will automatically recognize the battery type when it is powered on again. Then it can run it.

Notes:

- a. The ESC can be run after completing self-inspection (about 3 seconds) if power on, otherwise it cannot be operated normally.
- b. If there is no power output and the red light of ESC flashes quickly after power on, please check whether the throttle trim of the transmitter is set to the "0" position, the receiver will automatically recognize the midpoint of the trim throttle after restarting;
- c. If the rotation direction is not correct during running, exchange the two wires connecting motor and ESC.
- d. To make sure everything is ok, please turn on the transmitter first and finally turn on the ESC, turn off the ESC first and finally turn off the transmitter.

Notes: Please refer to the relevant sections for details about the battery type, drag brake force and running mode of the ESC.









Failsafe

This function is used to protect the safety of the model and the operator when the receiver cannot normally receive the signal from the transmitter and is out of control. The receiver defaults that the throttle channel is fixed to be out of control and enters the brake state. After other channels are out of control, the receiver has no signal output. If you set it on the transmitter, it will output according to the set value.

Attention:

- Make sure the product is installed and calibrated correctly, failure to do so may result in serious injury.
- Please carefully check each power device and car frame instructions to ensure the power matching is reasonable before use. Avoid damaging power system due to incorrect matching.
- Do not let the external temperature of the system exceed 90°C /194 °F , because high temperature will damage the power system.
- Make sure the receiver's battery is disconnected before turning off the transmitter, failure to do so may lead to unintended operation or loss of control.
- After use, remember to disconnect the battery and the ESC. If the battery isn't disconnected, the ESC will consume electric energy all the time even if it is off. It will discharge completely if connect the battery for a long time, thus resulting in the failure of the battery or the ESC. We are not responsible for any damage caused by this!
- Make sure the receiver is mounted away from motors or any device that emits excessive electrical noise.
- Keep the antenna of the receiver at least 1cm away from conductive materials such as carbon or metal.
- Do not power on the receiver during the setup process to prevent loss of control.

ESC Parameter Setting

Running Mode	Battery Type	Drag Brake	
 FWD/REV/BRK	 Lipo	 0%	 75%
 FWD/REV	 NiMH	 50%	 100%

Dial Switch sign

The Dial Switch on the transmitter is used to set ESC parameters, that is, the Dial Switch is located at different positions and the corresponding parameter values are different.

Setting Method:

There are three parameters can be set for the ESC, which are "Running mode", "Battery type", "Drag brake", There are slide switches numbered 1 2 3 4 on the radio panel . The above parameters can be set by dialing down and up. The specific operation is as follows:

When No. 1 slide switch is on the down, it indicates that the operation mode is set to FWD / REV / BRK.

When No. 1 slide switch is on the up, it indicates that the operation mode is set to FWD/REV.

When No. 2 slide switch is on the down, it indicates that the battery type is set to Lipo.

When No. 2 slide switch is on the up, it indicates that the battery type is set to NiMH.

When No. 3 and No.4 slide switch are on the down, it indicates that the drag brake force is set to 0%.

When No. 3 slide switch is on the down and No.4 slide switch is on the up, it indicates that the drag brake force is set to 50%.

When No. 3 slide switch is on the up and No.4 slide switch is on the down, it indicates that the drag brake force is set to 75%.

When No. 3 and No.4 slide switch are on the up, it indicates that the drag brake force is set to 100%.

Parameter Explanation:

1. Running Mode

FWD/REV/BRK: This mode adopts "double click" reverse mode, that is, when the throttle trigger is pushed from neutral range to the reverse area for the first time, the motor is only braking and will not reverse; when the throttle trigger is moved back to the neutral range and pushed to the reverse area for the second time, it will reverse. This mode is applicable to general models.

FWD/REV: This mode adopts "one click" reverse mode, that is, when the throttle trigger is pushed from neutral range to the reverse area, the motor immediately generates reverse action, which is generally applied to rock crawler.

Parameter setting method:

When No. 1 slide switch is on the down, it indicates that the operation mode is set to FWD / REV / BRK.

When No. 1 slide switch is on the up, it indicates that the operation mode is set to FWD/REV.

2. Battery Type

There are LiPo and NiMH cells. The low-pressure protection value is different under different types. It can be set according to the actual use.

Parameter setting method:

When No. 2 slide switch is on the down, it indicates that the battery type is set to Lipo.

When No. 2 slide switch is on the up, it indicates that the battery type is set to NiMH.

3. Drag Brake Force

The drag brake means that when the throttle trigger moves from the forward or reverse area to neutral range, it will produce certain braking force to the motor, the larger the value is, the greater the drag brake force is. Select proper braking force according to the actual situation.

Parameter setting method:

When No. 3 and No.4 slide switch are on the down, it indicates that the drag brake force is set to 0%.

When No. 3 slide switch is on the down and No.4 slide switch is on the up, it indicates that the drag brake force is set to 50%.

When No. 3 slide switch is on the up and No.4 slide switch is on the down, it indicates that the drag brake force is set to 75%.

When No. 3 and No.4 slide switch are on the up, it indicates that the drag brake force is set to 100%.



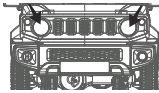
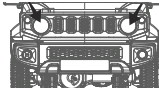
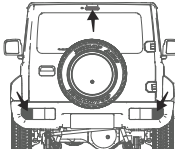
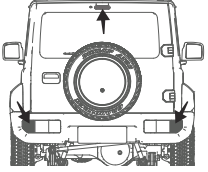
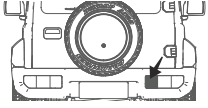
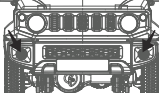
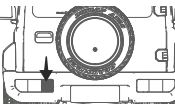
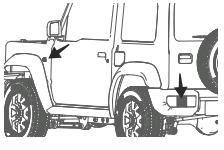
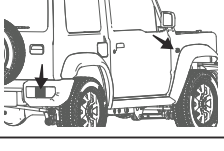



Lighting function

Button	Light Position	Function	Power on is off by default	Times for Pressing					Control Mod	Remarks	
				I	II	III	IV	V			
CH4	Headlight	White headlights keep on		OFF	•	OFF	OFF	OFF			
		White headlights keep on with high brightness		OFF	OFF	•	•	OFF			
	Taillights	Taillights keep on		OFF	•	•	•	OFF			
		Taillights turn red with high brightness amid brake operation		○	○	○	○	○	Throttle linkage control	Brake lights are on with high brightness amid brake operation	
		Reversing white lights		○	○	○	○	○	Throttle linkage control	Reverse lights are on amid reverse operation	
	Fog lamp	The yellow headlights keep on		OFF	OFF	OFF	•	•			
		The red taillights keep on		OFF	OFF	OFF	•	•			
	Turn Signal	Left turn yellow light		OFF	○	○	○	○	Direction linkage control	3 left turn signals automatically blink in the left turn with a 1-sec flashing frequency, namely on 0.5 sec and off 0.5 sec.	
		Right turn yellow light		OFF	○	○	○	○	Direction linkage control	3 right turn signals automatically blink in the right turn with a 1-sec flashing frequency, namely on 0.5 sec and off 0.5 sec.	
		The brake lights show double flash in the left and right turn.		OFF	OFF	OFF	•	OFF		A total of 6 left and right turn signals flash automatically regardless of direction with a 1-sec flashing frequency, namely on 0.5 sec and off 0.5 sec.	

Getting started

Before operation, install the battery and connect the system as instructed below.

★ Transmitter Battery Installation

 Danger	Only use specified battery (X4 AA batteries).
 Danger	Do not open, disassemble, or attempt to repair the battery.
 Danger	Do not crush/puncture the battery, or short the external contacts.
 Danger	Do not expose to excessive heat or liquids.
 Danger	Do not drop the battery or expose to strong shocks or vibrations.
 Danger	Always store the battery in a cool, dry place.
 Danger	Do not use the battery if damaged.

Battery Type: AAA

Battery Installation:

1. Open the battery compartment cover.
2. Insert 4 fully-charged AAA batteries into the compartment. Make sure that the battery makes good contact with the battery compartment's contacts.
3. Replace battery compartment cover.

Low battery alarm: When the battery is lower than 4.2V, the LED on the panel will flash slowly.

Instructions

After setting up, follow the instructions below to operate the system.

1. Automatic code matching (the transmitter and receiver have been successfully coded before leaving the factory.)

If you need to replace another transmitter or receiver, please follow the following steps to code:

1. When the transmitter power is on and the code matching mode is on, the light keeps flashing;
2. The power supply of the receiving board is turned on, and the front lights keep flashing to enter the code matching mode;
3. When the code matching is successful, all the transmitter lights are on and all the lights on the car are off;

Note: when code matching, please operate the transmitter to enter the code matching state first, and then operate the receiver to enter the code matching state.

2. POWER OFF

Follow the steps below to turn off the system:

1. Disconnect the receiver power.
2. Toggle the transmitter's power switch to the off position.



Danger

Make sure to disconnect the receiver power before turning off the transmitter. Failure to do so may lead to damage or serious injury.

Instructions

1. Transmitter specification

Product Model	FS-MG41
Channels	4
Model Type	Car, Boat
RF	2.4GHz ISM
RF Power	<20dBm
2.4GHz Protocol	ANT
Distance	>150m(ground)
Channel Resolution	1024
Battery	6V DC 1.5AAA*4
Charging Interface	NO
Life time	According to battery type
Low Voltage Warning	<4.2V
Antenna Type	Built-in single antenna
Data Interface	No
Temperature Range	-10°C— +60°C
Humidity Range	20—95%
Online Update	No
Color	Black
size	118mm x 73mm x 145mm
weight	130g
Certification	CE,FCC ID:N4ZMG400

THROTTLE STICK POSITION

Throttle stick position

Neutral point

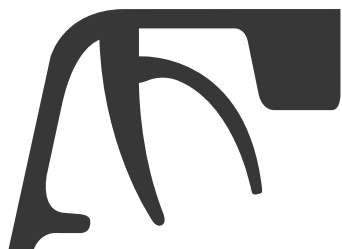

Top point of forward direction

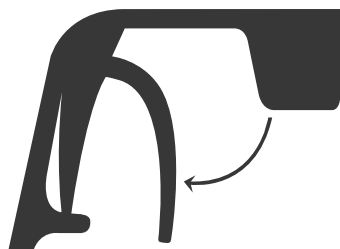

Top point of backward direction

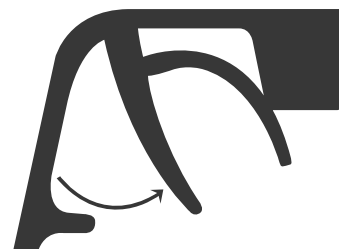

VEHICLE SETUP

Connecting the battery

Step 1: open the hood.

Step 2: place the battery in the battery box and connect the battery plug.

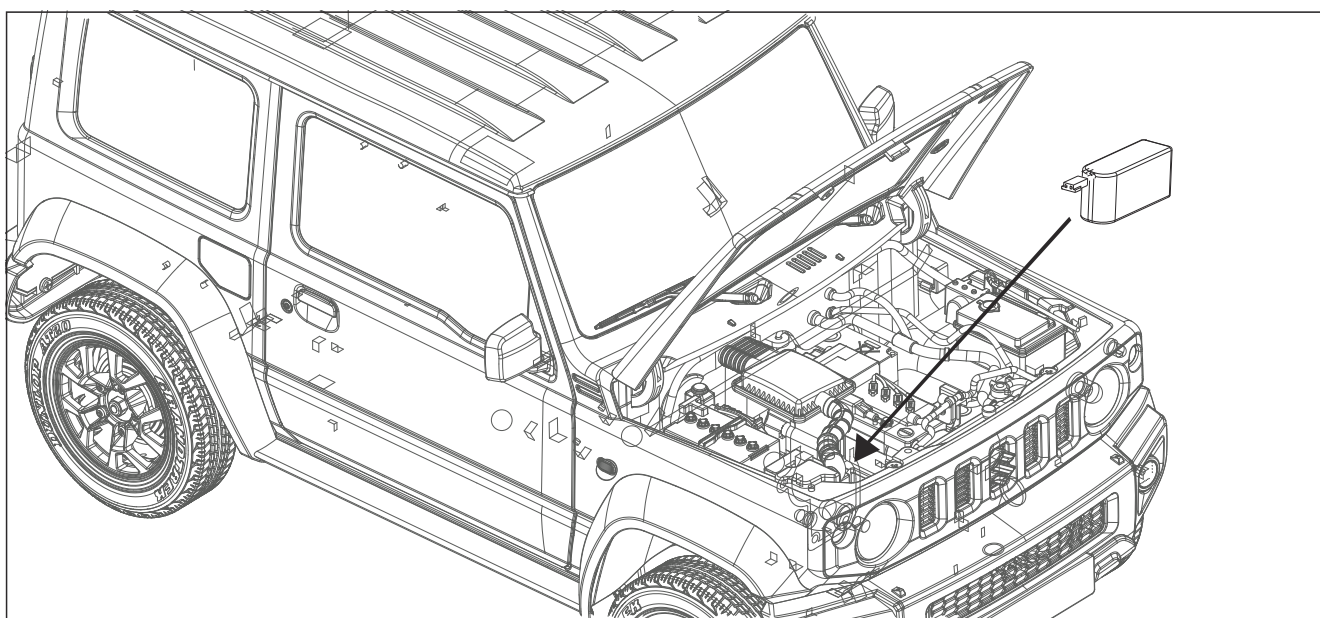

OPERATING THE VEHICLE

Step 1: turn on the transmitter, the headlamp of the transmitter will flash and enter the frequency matching mode.

Step 2: turn on the receiver switch, the headlight will flash and enter the frequency matching mode.

Step 3: when the transmitter and receiver are successful in frequency up, the front lights of the transmitter will be on for a long time, and the front lights of the vehicle will be off.

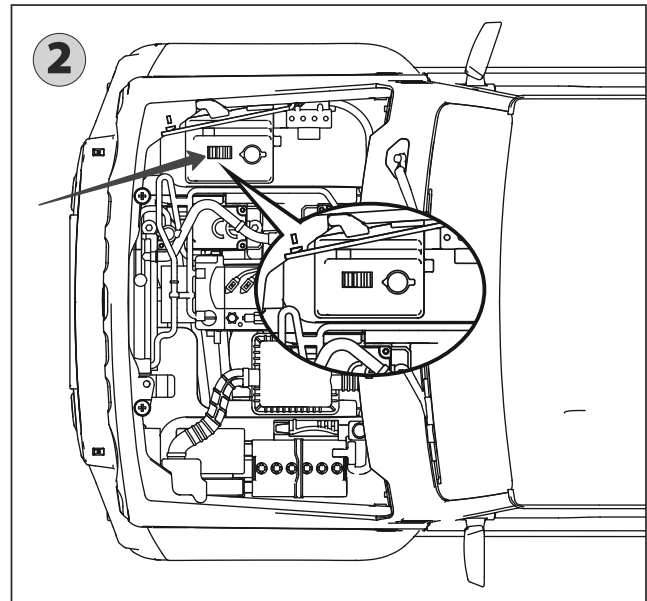
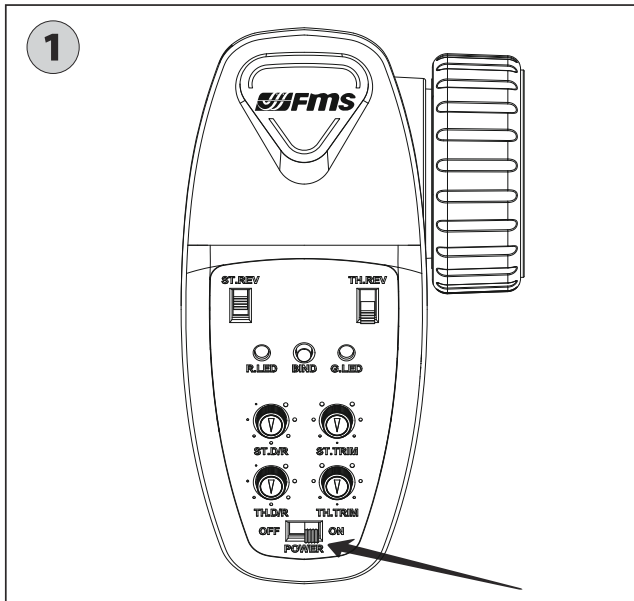

DISTRIBUTOR

North America:

Horizon Hobby LLC

2904 Research Road
Champaign, IL 61822, USA
Tel.: 217-403-3584

Sweden:

Minicars Hobby Distribution AB

Annelundsgatan 17C
749 40 Enköping, Sweden
Tel.: +46-171-14 30 02

The United Kingdom:

CML Distribution Ltd

Saxon House, Saxon Business Park, Hanbury Road
Bromsgrove, Worcestershire
B60 4AD, England
Tel.: +44 (0)1527 575349

Australia:

Model Engines Pty Ltd

Unit 1/32 Bluett Drive
Smeaton Grange
NSW 2567 Australia
Tel.: +61(0)411128284